

Multimediaterminal SM2000handicap

Operating and Installation Instructions



2002-3

MEDIA LINE Consulting

39044 EGNA (BZ) ITALY - VIA STAZIONE, 17 - TEL. + 39 0471 813080 - Fax + 39 0471 813280

E-mail: info@media-line.it - www.media-line.it - www.terminals.it

The manufacturer reserves the right to make any changes, at any time and without notice.

Multimediaterminal SM2000handicap

Contents

Introduction	3
1 Technical Data	6
1.1 General features	6
1.2 Basic features.....	7
1.3 Components of the SM2000handicap	8
1.3.1 Integrated loudspeakers.....	10
1.3.2 LC-display with touchscreen.....	10
1.3.3 Badge reader / smart card reader.....	10
1.3.4 Keyboard with integrated mouse-pad / trackball (optional).....	10
1.3.5 Maintenance lid with lock.....	10
1.3.6 Aluminium roller shutter with lock.....	10
1.3.7 Shifting mechanism (optional)	10
1.4 Connections of the SM2000handicap	12
2 Installation instructions	14
2.1 Packaging of the SM2000handicap	14
2.2 Installation of the SM2000handicap	16
2.3 Putting into operation.....	18
3 Operating instructions	19
3.1.1 Lowering of the upper column half.....	20
3.1.2 Keyboard use (optional).....	20
3.1.3 Working with the touchscreen (optional).....	20
3.1.4 Use of the card reader (optional).....	20
4 Maintenance instructions	21
4.1 Daily maintenance	21
4.2 Maintenance of the electrical and mechanical components.....	21
4.2.1 Maintenance lid with lock.....	21
4.2.2 Aluminium roller shutter with lock.....	22
4.2.3 Mechanism to shift the upper column half	22
4.2.4 Mechanism to shift the entire terminal onto the second base plate (optional)	23
5 Service instructions	24
6 Enclosures	25

Multimediaterminal SM2000handicap

Introduction

Foreword

The aim of these instructions is to help you install and operate the SM2000. The information they contain have been carefully controlled but we accept no responsibility or liability for any damage resulting from the abuse or improper use of this documentation. The information provided in these instructions may be changed by MEDIA LINE Consulting without notice and therefore is not binding for MEDIA LINE Consulting.

The partial or total duplication of these instructions is subject in any case to MEDIA LINE Consulting's permission.

For any questions, please contact MEDIA LINE Consulting. Internet users may contact us at our e-mail address: info@media-line.it

Multimediaterminal SM2000handicap

General Indications



The "Information" icon indicates a specific technology or information which could help you perform a task or better understand a process.



The "Attention!" icon indicates that a certain process may cause problems or may damage hardware, software or data.







The "Danger!" icon warns that a certain process will cause safety and health problems for people or damage hardware, software or data.

Indications concerning ESD components



This symbol indicates the ESD components (Electro Static Discharge).

In handling components marked with this symbol please follow these indications:

-  Before starting working with the ESD components, discharge any electrostatic charges you may have accumulated on your person.
-  Eliminate electrostatic charges from all necessary working tools.
-  Make sure that you have pulled out the power plug before inserting or removing ESD components.
-  Always touch the ESD components on their sides and avoid touching the electric contacts.

Multimediaterminal SM2000handicap

Attention



Connection to the power mains should be in the immediate vicinity of the **SM2000handicap** and easily accessible.



The **SM2000handicap** model with CD-ROM drive is equipped with a Class 1 laser. Do not try to start the machine when it is open. Do not try to open the lid of the CD-ROM drive. The CD-ROM drive is maintenance-free. If faulty, the entire unit is replaced..

Attention

The following precautions apply when using components operated by a lithium battery:



Explosion hazard if the battery is inserted incorrectly. Replace the battery only with another of the same or equivalent model, recommended by the dealer.

Batteries must be disposed of in compliance with the norms in force.

Attention

Any repair work inside the machine shall be performed only by qualified staff in voltage-free conditions and in compliance with the wiring diagram. ADM International waives all responsibility for improper and unprofessional tampering with the machine. Improper replacements of single parts or incorrect operations on the machine may cause partial damage and therefore invalidate the warranty. Damaged machines and machines with faulty supply cables should not be further operated and should be immediately disconnected. Faulty or damaged parts must be replaced with original spare parts.

Multimediaterminal **SM2000**handicap

1 Technical Data

1.1 General features



SM2000handicap distinguishes itself for its qualified technology and user-friendliness. A small handle permits to lower and bring forwards the upper part in one continuous movement, thereby meeting different users' needs.



SM2000handicap was designed to offer maximum safety for the user: the entire motion mechanism is housed in a stylish casing box.



Multimediaterminal SM2000handicap

1.2 Basic features

Dimensions

	Closed position	Lowered position
Dimensions of SM2000handicap:		
Height	1600 mm	1460 mm
Width	560 mm	560 mm
Depth (without keyboard)	680 mm	1130 mm
Depth (with keyboard)	780 mm	1230 mm
Height of single components		
Keyboard:	950 mm	810 mm
Screen:	1320 mm	1180 mm
Printer unit:	560 mm	560 mm

Operating conditions

Ambient temperature: von 10° bis 40° C

Humidity: von 20 % bis 80 %

Connection to the power mains

Requirements of the power mains:

- 220-240 V (+10%, -15%), 50-60 Hz
- consumption 50-80 W
- good grounding



Multimediaterminal SM2000handicap

1.3 Components of the SM2000handicap

Front

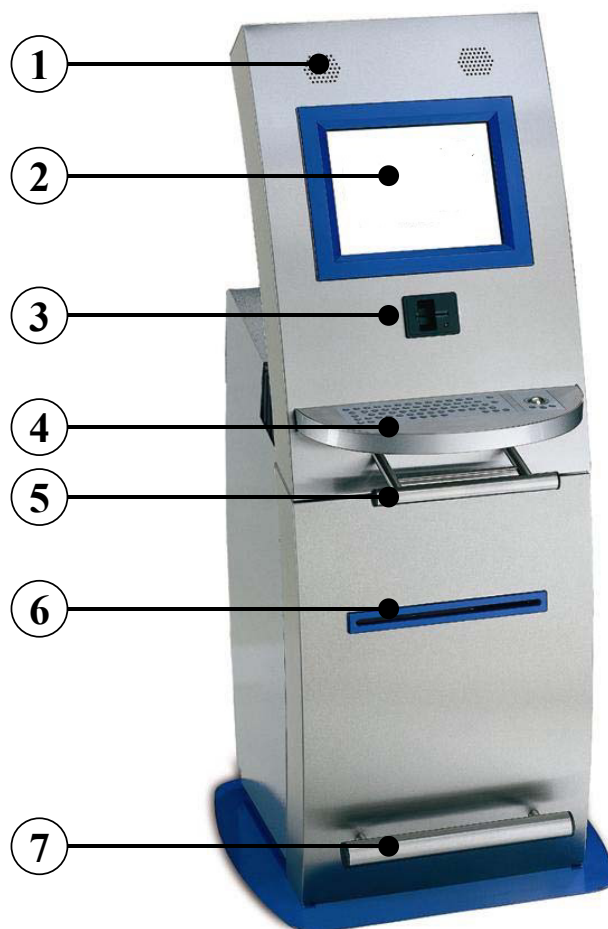

1. Integrated loudspeakers
2. LC-display with optional touchscreen
3. badge reader/smart-card reader (optional)
4. keyboard with integrated mouse-pad/trackball (optional)
5. handle to shift the upper column half
6. printer opening (optional)
7. supporting protective ledge

Multimediaterminal SM2000handicap

Rear

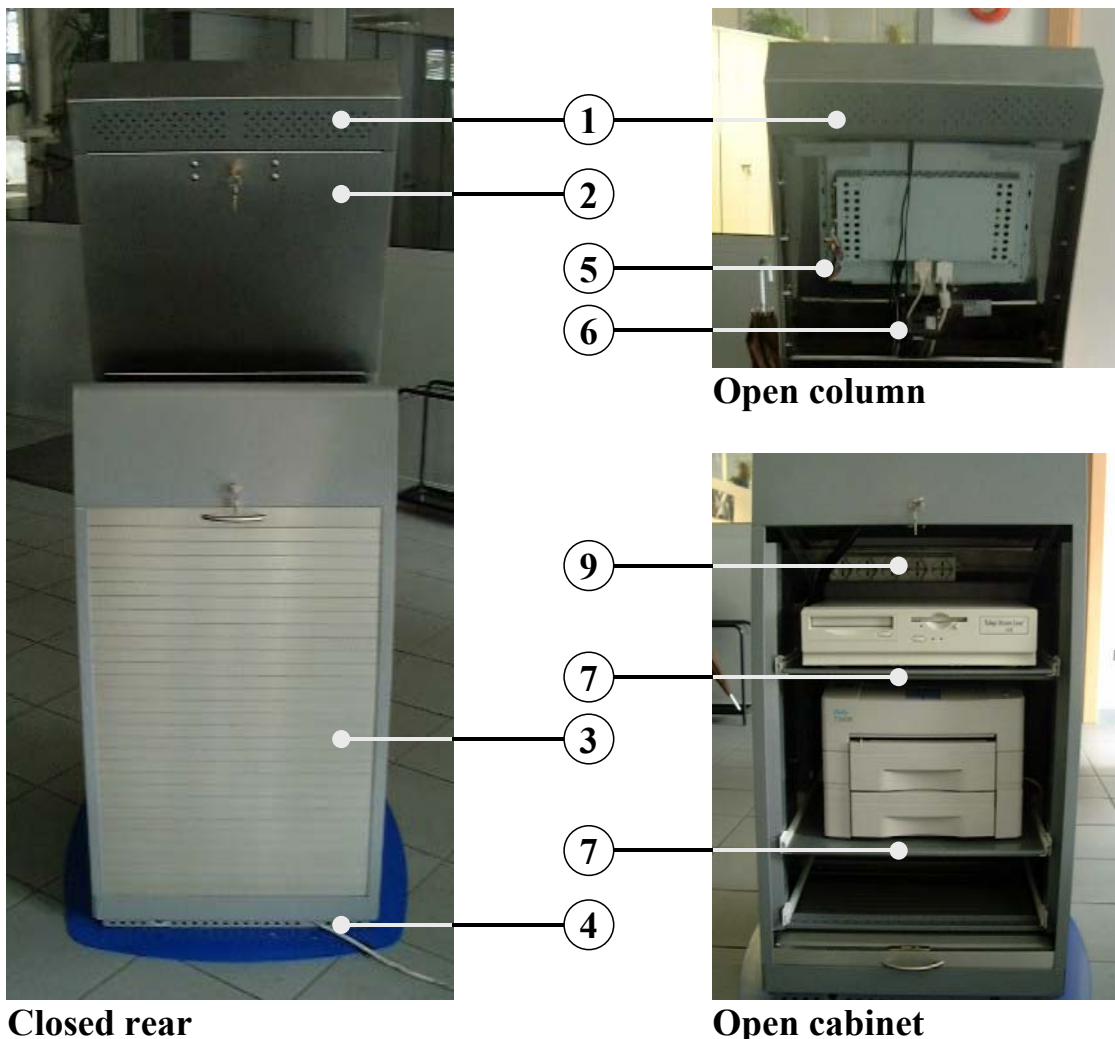

1. Ventilation slots to cool down the monitor
2. Maintenance lid with lock
3. Cabinet with robust aluminium roller shutter and lock
4. Base trim with openings for power and supply system cables
5. Rear of LCD monitor with switches to fit to PC
6. Rear of card reader
7. Pull-out drawers for PC and printer (specific arrangement of PC and printer is possible depending on configuration)
8. Metal plate guides for paper (tailored to client's printer requirements) (behind the printer, in the picture)
9. Multiple socket for plugs with main switch

A description of the single system components follows.

Multimediaterminal

SM2000handicap

1.3.1 Integrated loudspeakers

Two 15 Watt quality stereo loudspeakers are installed in the **SM2000handicap** for a better acoustic performance. PC connector slot available.

1.3.2 LC-display with touchscreen

The 15" LC-display can be equipped with a capacitive touchscreen. For installation, follow the specific instructions provided in the installation CD enclosed. It is also possible to install a so-called "privacy filter" enabling screen viewing only for the person right in front of the terminal. In this way, privacy from side observation is ensured.

1.3.3 Badge reader / smart card reader

The badge reader is a standard installation. PC connector slot available.

Other devices can be installed at clients' request. Specific indications are given in the enclosed operating instructions.

1.3.4 Keyboard with integrated mouse-pad / trackball (optional)

The stainless steel keyboard is available with or without mouse-pad/trackball (IP 63 protection class). It is vandal-resistant and yet very ergonomic: this is the ideal prerequisite for longer texts in the Internet.

1.3.5 Maintenance lid with lock

The lid can be locked, thereby preventing unauthorised opening. To open, turn the key to the left.

If needed, behind the maintenance lid you can gain access to the loudspeakers, the LC display and the card reader for maintenance purposes. Specific indications are given in the enclosed device-specific instructions..

1.3.6 Aluminium roller shutter with lock

The machine cabinet is protected by a solid aluminium roller shutter against unauthorised access. At the same time, it permits to perform a number of operations - e.g. paper reloading - rapidly. To open: turn the key slightly to the right. To close: pull up the roller shutter until it automatically engages.

Behind the roller shutter are the pull-out drawers for printer and PC. For the maintenance of these devices, please follow the manufacturer's instructions.

1.3.7 Shifting mechanism (optional)

For ready access to the terminal from its rear, an optional shifting mechanism is available. It permits to move approx. 45 cm forwards the entire machine using a second base plate, on the plate fixed to the floor.



Multimediaterminal

SM2000handicap

To operate, open the roller shutter and pull out the blocking button on the left to unblock it. Then you can move forwards the entire kiosk.

Please consider the following:



-  Make sure that the floor in front of the machine is even and free of obstacles.
-  Only trained staff may unblock the blocking device and move the machine.
-  When bringing back the machine to its original position, watch out for the danger of crushing. The blocking mechanism engages automatically.

Multimediaterminal SM2000handicap

1.4 Connections of the SM2000handicap



Before establishing any connections and in order to avoid damage, make sure that the **SM2000handicap** is switched off. Connection to the power mains should be in the immediate vicinity of the computer and easily accessible..



SM2000handicap has two openings on its rear for the power mains (1) and the supply cable (2). Specific tools are available to help install the cables.

Avoid working with **SM2000handicap**'s connections during a thunderstorm.

To pull out a cable from the socket, always take hold of and pull the plug and never the cable.

Position the supply cable in such a way that no one can trip in it and that no other devices such as vacuum cleaners, floor cleaning appliances or vehicles may damage it. If needed, provide a sufficient cover or other device preventing tensile stress for the supply cable.



A correct connection of the **SM2000handicap** to the power mains is the essential prerequisite for the correct operation of the machine. Therefore, carefully check that:



Voltage ranges are within the established limits,

Multimediaterminal SM2000handicap



No high-consumption electromechanical devices are connected to the same line,



It is properly grounded,



No devices presenting a risk of dispersion are connected to the grounding system, also in order to comply with safety norms.

If voltage differs from reference values, even temporarily, use a voltage stabiliser. Furthermore, in case of repeated power failures, we suggest using a UPS (300/600W model) to avoid possible damage to the system..

Now simply connect the **SM2000handicap** to the power mains with the plug and start it up.

Multimediaterminal **SM2000**handicap

2 Installation instructions

2.1 Packaging of the **SM2000**handicap

SM2000handicap is supplied mounted on a euro pallet. For protection purposes, a cardboard packaging is also used.



Mounted on pallet

Cardboard packaging

To unpack, first of all remove the cardboard cover and - if possible - bring the kiosk on the euro pallet to its installation site. If this is not possible, have at least four people hold the **SM2000**handicap at the corners of the base plate and transport it to its final installation site. Since it is rather top-heavy, be very careful in tilting it. When picking it up and putting it down again, take care not to crush your fingers.

Multimediaterminal

SM2000handicap



The keyboard housing cannot be used to take hold of and carry the machine. Never try to pick up the machine by seizing it there.

Removal of packaging and content check:



Keep the original packaging and the packaging material. The original packaging is needed if you send the machine to the assistance for repair work and to protect the **SM2000handicap** when transporting it,







Make sure that the parts in the packaging have not suffered visible transport damage.
If you notice transport damage or differences between the packaging content and the delivery note, contact your dealer immediately.

Multimediaterminal SM2000handicap

2.2 Installation of the SM2000handicap

Before installing the **SM2000handicap**, make sure that the installation site meets the following requirements:

-  As any other electronic device, the **SM2000handicap** shall be installed in an appropriate place, sufficiently cool and dry and well ventilated.
-  **SM2000handicap** cannot be placed in direct sunlight or close to heat sources.
-  Do not place the **SM2000handicap** next to heating elements or other heat sources. If you install the **SM2000handicap** close to a wall, make sure that there is sufficient space for proper ventilation.
-  Do not place electronic devices working with frequencies, such as stereo units or TVs, close to the **SM2000handicap**.
-  Furthermore, respect a safety distance of at least 1 m from magnetic fields (loudspeakers, magnets, etc.) which can destroy data on diskettes and hard disk.

Safety distance



You need to have a safety distance between the **SM2000handicap** and the wall of at least 20-30 cm to allow for proper heat dispersion, to reload the printer with paper and to have access to it for maintenance purposes.

Multimediaterminal SM2000handicap

Space for Operation



The specific feature of the **SM2000handicap** is the possibility to pull out the upper column half. To guarantee optimal access to the machine also when it is pulled out, you need a space of at least 2 m, especially for access by people sitting on a wheelchair.

Fixing to the floor

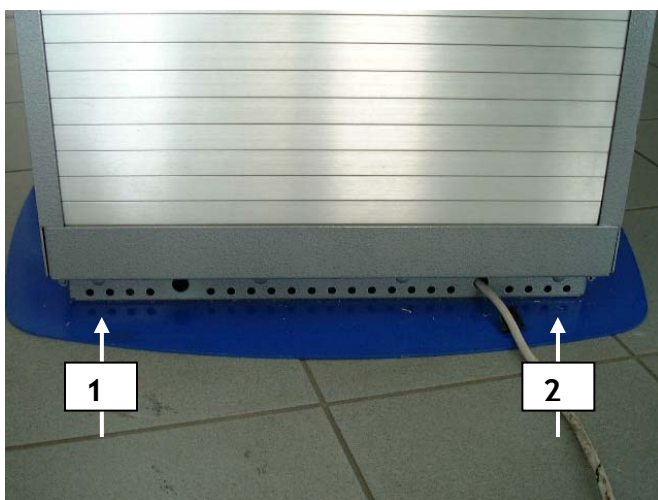

Before putting the **SM2000handicap** in operation, you need to anchor it to the floor using the two specific openings (1 and 2) in the base plate and the supplied screws.



Otherwise, once pulled out, the machine could tilt forwards when pressure is applied on the keyboard, thereby endangering the user.

Multimediaterminal

SM2000handicap

2.3 Putting into operation

First start-up:

When you start up the **SM2000**handicap the first time, proceed as follows::







1. Choose the place where the **SM2000**handicap is to be installed, following the instructions provided under the technical data and chapter 3.2.
2. Check voltage and connect the **SM2000**handicap to the power mains, following the instructions provided under the technical data and chapter 2.4.
3. To start up the components you install, such as PC, printer etc., please follow the specific instructions of the components' manufacturer

Multimediaterminal

SM2000handicap

3 Operating instructions

During operation, follow the instructions given below in order to guarantee a safe and smooth operation of the **SM2000handicap**.

-  Do not expose the **SM2000handicap** to humidity. Avoid bringing it in contact with rain, humidity or other fluids in order to prevent the danger of fire or short-circuits.
-  The openings and ventilation slots on the sides of the base and on the rear of the column permit proper ventilation of the **SM2000handicap**, thereby guaranteeing reliable operation, and protect it against overheating. Avoid covering or blocking up these openings.
-  The voltage at which the **SM2000handicap** is connected shall correspond to that indicated on the label on the rear of the computer. If you have doubts or questions, please ask your dealer.
-  Place the supply cable in a way that it is not exposed to harmful influences, such as rubbing, pulling, twisting, tension, etc.
-  If you use an extension lead, make sure that it is not overloaded.
-  Avoid inserting objects of any kind into the ventilation slots, which could touch the high voltage points and cause short-circuits or fires.

Below, the specific features of the **SM2000handicap** are described

Multimediaterminal SM2000handicap

3.1.1 Lowering of the upper column half



The position of the upper column half of the **SM2000handicap** can be easily changed using the handle placed under the keyboard. Grab the handle ② with one hand and pull forwards the small bracket ① with your fingers. In this way you disengage the motion mechanism and you can shift the column forwards.

To push back the column, use the handle ② in the same way. By applying a light pressure, the column goes back to its original position.



If you act improperly when pushing back the upper column half, you risk finger-crushing in the area between the lower and upper column half. This area is marked by this symbol on both sides.

3.1.2 Keyboard use (optional)

See the enclosed keyboard instructions

3.1.3 Working with the touchscreen (optional)

See the enclosed touchscreen instructions

3.1.4 Use of the card reader (optional)

See the enclosed card reader instructions



Multimediaterminal



SM2000handicap

4 Maintenance instructions

Maintenance of the **SM2000handicap** is of two kinds. Daily maintenance is mainly external while it is possible to operate on the electrical components only through the two maintenance openings.

4.1 Daily maintenance

-  Before cleaning, always turn off the **SM2000handicap** and pull out the power plug.
-  To clean the stainless steel surface use only the stainless steel cleaning product supplied. While cleaning, watch out that no fluid leaks into the machine through the openings for loudspeakers, microphone and ventilation. Use of a small amount of liquid is therefore recommended.
-  To clean the touchscreen and card reader, use a special cleaning product (available in specialist shops). During cleaning, devices have to be switched off, to avoid improper use. Be careful that no cleaning liquids leak into the devices.

-  The keyboard should be cleaned with a self-evaporating cleaning product (for instance: window cleaning product). During cleaning, disconnect the keyboard to avoid improper use.
-  Clean the frames of the printer unit and of the screen with a mild cleaning product since products containing alcohol or corrosive products in time may damage the surface.
-  In case of faulty operation, never try to repair the **SM2000handicap** on your own but disconnect it from the power mains and ask for qualified help

4.2 Maintenance of the electrical and mechanical components

The maintenance of the electrical and mechanical components is performed through the maintenance lid and the roller shutter. Before opening the **SM2000handicap** make sure that the device is disconnected from the power mains.

4.2.1 Maintenance lid with lock

The lid can be locked and is therefore protected against unauthorised opening. To open it, turn the key to the left.

Multimediaterminal

SM2000handicap

If needed, behind the maintenance lid you can gain access to the loudspeakers, the LC display and the card reader for maintenance purposes. Specific indications are given in the enclosed device-specific instructions.



4.2.2 Aluminium roller shutter with lock

The machine cabinet is protected by a solid aluminium roller shutter against unauthorised access. At the same time, it permits to perform a number of operations - e.g. paper reloading - rapidly. To open: turn the key slightly to the right. To close: pull up the roller shutter until it automatically engages.

Behind the roller shutter are the pull-out drawers for printer and PC. For the maintenance of these devices, please follow the manufacturer's instructions.

4.2.3 Mechanism to shift the upper column half

Only trained service staff may maintain and repair this mechanism. To do this, the corresponding covers have to be removed.

-  Please refer to the accompanying instructions of the gas spring manufacturer
-  Improper handling and forced opening of the gas spring may cause danger and damage for people.

Multimediaterminal SM2000handicap

4.2.4 Mechanism to shift the entire terminal onto the second base plate (optional)

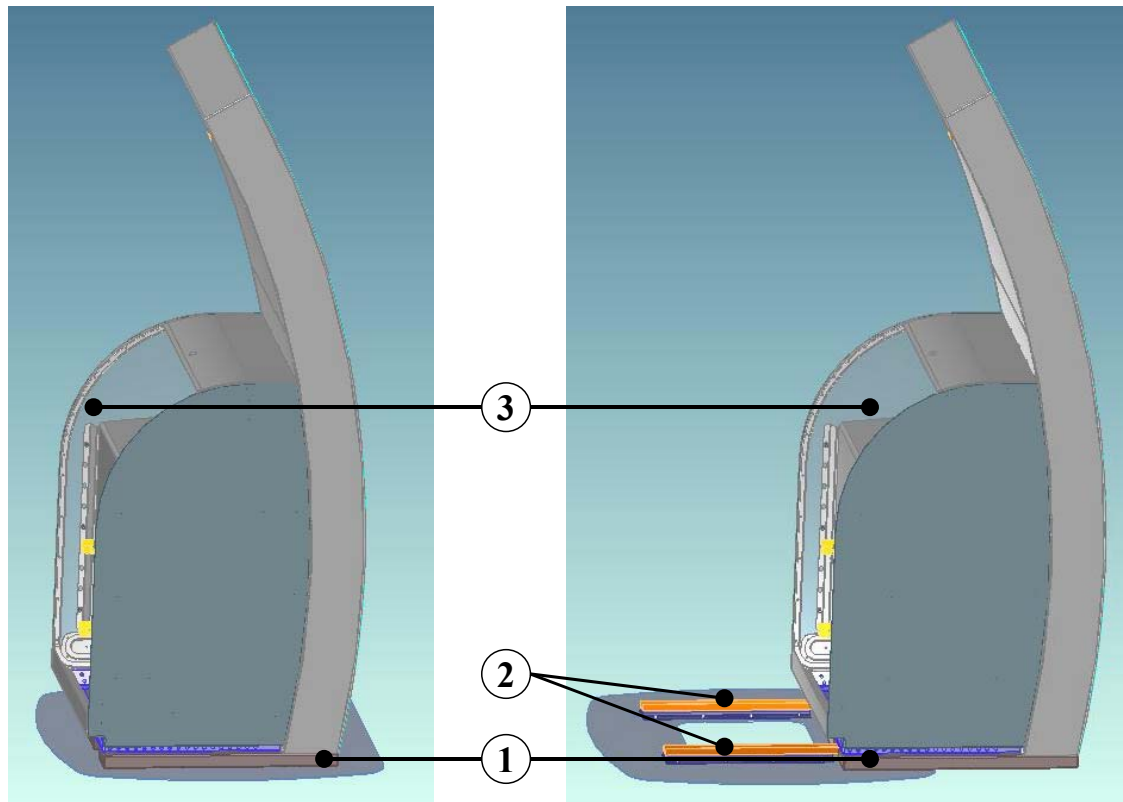

Closed Kiosk

Lowered Kiosk

SM2000handicap is equipped, as an optional, with a shifting device. To operate, pull the handle (3) to disengage the blocking mechanism. The entire kiosk can now be moved approx. 40 cm forwards on the intermediate plate (1) on the integrated rails (2).

To bring it back to its original position, push back the kiosk until the blocking mechanism engages automatically

The disengaging button (3) is accessible only when the roller shutter is open and therefore can be activated only by trained staff. When shifting the machine, make sure that no obstacles on the floor in front of the kiosk could hamper its movement. When pushing it back, watch out for the danger of finger-crushing.

Multimediaterminal **SM2000**handicap

5 Service instructions



If the **SM2000**handicap does not work properly even though you have followed the instructions correctly, carry out the check operations alone described in the instructions.

Improper setting of the motion mechanisms may cause damage or complications to the **SM2000**handicap.

Multimediaterminal SM2000handicap

6 Enclosures

The instructions needed for the safe operation of the integrated electrical components are enclosed:

- LCD-Monitor
- Card reader (optional)
- Keyboard with integrated trackball/touch pad (optional)
- Loudspeakers
- Amplifier (optional)
- Personal Computer (PC)
- Printer
- Mikrophone (optional)
- Videocamera (optional)
- Gas spring